



Terra Select

Windsifter

The realisation that natural resources are finite has pushed people into thinking about their lifestyle. This is why we are now more attuned to the idea of nature being a valuable asset that needs to be safeguarded for future generations. The development of sustainable solutions is the active way to contribute to a future worth living, and is something that our employees engage in on a day-to-day basis.

Karlgünter Eggersmann,
CEO

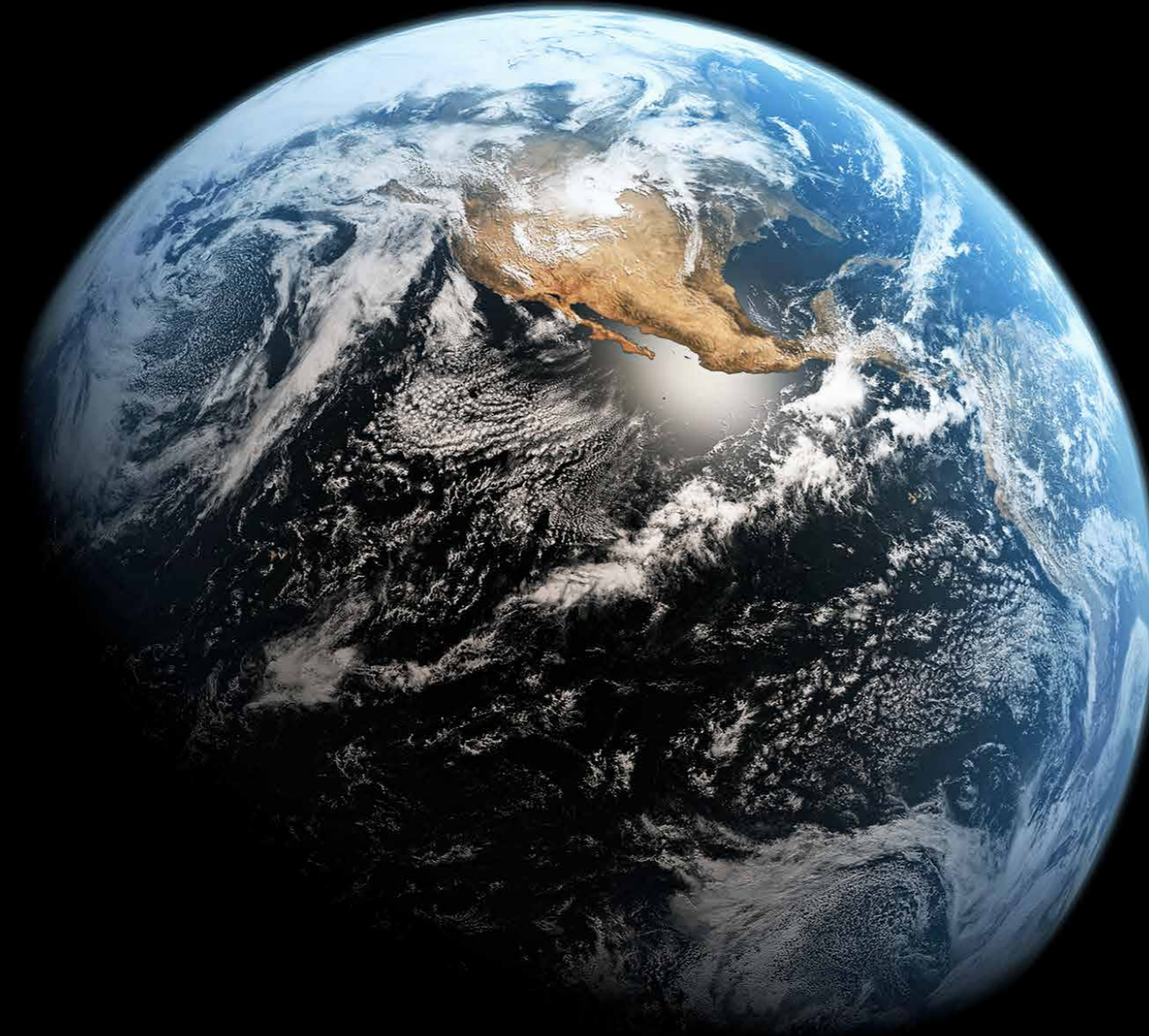

Navigation

p. 4 Terra Select V 40 / V 60

p. 6 Terra Select WE 60

p. 8 Terra Select W 70

p. 10 Terra Select W 80

V 40 / V 60



Technical data

Syphon unit width	
V 40	800 mm
V 60	1,000 mm or 1.200 mm
Drive (hydraulic via trommel screen or electric)	20.5 kW

Working and transport position

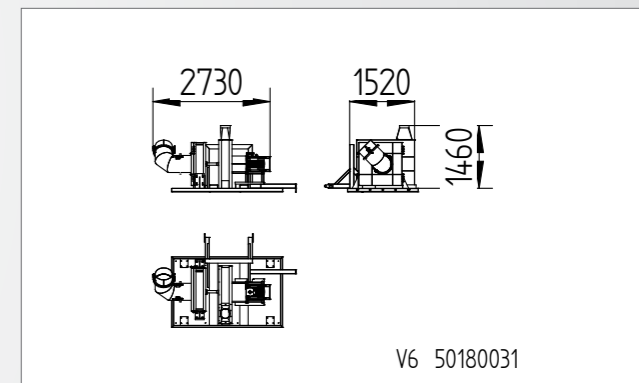

Terra Select V 40 / V 60

The V 40 / V 60 Windsifter can be used for continuous cleaning of coarse grain material when screening with a trommel screening machine. It is fitted to the end of the coarse grain conveyor. Air is blown under the material and impurities are syphoned away. The V 40 / V 60 Windsifter is powered hydraulically via the screening machine or electrically.

- The V 40 and V 60 Windsifter operate with a suction/pressure fan with a capacity of 20.5 kW. This fan is mounted on the container which is filled with the impurities to be syphoned.
- The syphon unit is moved with ease using the prongs of a forklift truck or a quick-change unit.
- Applications: biomass fractions, compost, recycling materials

Special features: ease of handling, an efficient, cost-effective solution

WE 60



Technical data

Acceleration belt length	5,650 mm
Acceleration belt width	1,340 mm
Electric drive	35 kW
Optionally via generator	48 kVA
Suction fan	22 kW
Pressure fan	5.5 kW
Discharge belt length	5,800 mm
Discharge belt width	1,000 mm
Stone separation belt length	2,100 mm
Stone separation belt width	1,000 mm
Approved total weight	12,000 kg

Terra Select WE 60

The WE 60 Windsifter is a mainly semi-stationary or stationary and entirely electric Windsifter. Terra Select provides this Windsifter in two versions. The mobile WE 60 is mounted on the ABS 80 km/h road-legal chassis, and an entirely stationary solution is also available.

- Both machines use the same cleaning technology. The material is ideally fed into the WE 60 from a screening machine coarse grain conveyor, then distributed by an acceleration belt. The material is blown through by the pressure fan at the end of the conveyor and aspirated by the suction fan.
- Applications: biomass fractions, screen overflows from the compost process, biocompost

Special features: direct interaction with an upstream screening machine, higher cleaning level, lower operating costs

Working position

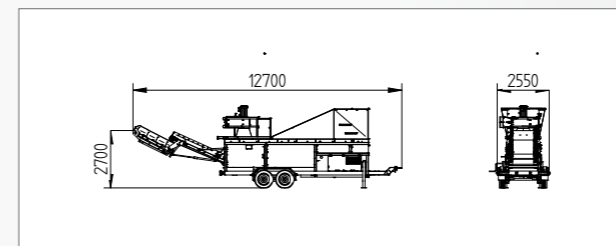

Transport position

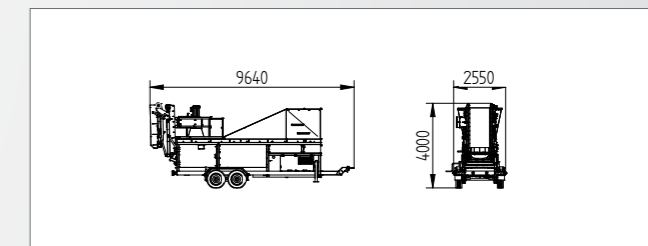

Stone separation conveyor at rear



Magnet roller



Stationärer Windsifter - Terra Select WE 60

W 70



Technical data

Drive	55 kW
Tank capacity	180 litres
Suction fan	22 kW
Pressure fan	5.5 kW
Acceleration belt length	3,400 mm
Acceleration belt width	1,340 mm
Discharge belt length	5,800 mm
Discharge belt width	1,000 mm
Stone separation belt length	2,100 mm
Stone separation belt width	1,000 mm
Hopper	4 m ³
Width	3,650 mm
Depth	1,800 mm
Approved total weight	12,000 kg

Terra Select W 70

The W 70 Windsifter is designed for cleaning light impurities out of screen overflows in composting and biomass recycling. Impressive cleaning performances are achieved, thanks to a dedicated infeed hopper with an integrated metering roller, and it is completely mobile. Materials which have already been screened can be cleansed of impurities completely independently of the screening machine.

- The infeed hopper is equipped with the proven positive-fitting drive system of the Terra Select trommel screens. In addition, a metering roller ensures an even infeed of material into the machine.
- The W 70 Windsifter impresses with a high, continuously adjustable cleaning level at throughput rates of up to 80 m³/h.
- The machine is a maintenance-friendly design, and all functions are hydraulically powered.

Special features: hopper with metering roller, stone separation and magnet roller

Working position

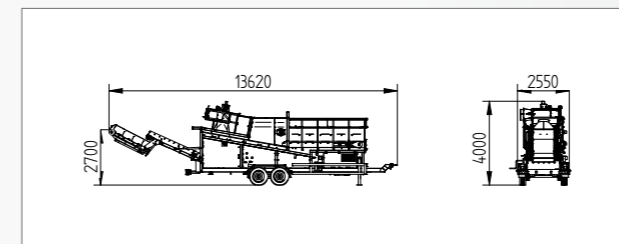

Transport position

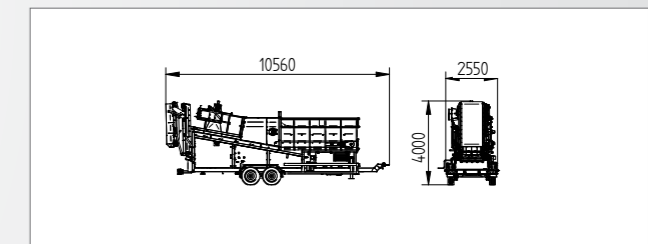

Remote control unit



Metering roller



Windsifter - Terra Select W 70, optional feeding by wheel loader or directly by a screening machine.

W 80



Technical data

Drive	81 kW
Tank capacity	260 litres
Pressure fan	up to 45 kW
Discharge conveyor, heavy fraction:	
Length	6,700 mm
Width	1,000 mm
Discharge conveyor, light fraction (optional):	
Length	6,700 mm
Width	1,000 mm
Hopper	> 5.5 m ³
Width	3,700 mm
Depth	1,850 mm
Approved total weight	15,400 kg

Terra Select W 80

The W 80 Windsifter is designed for separating heavy materials. For example, stones can be separated from woody materials. Wood from building rubble can be separated and used as substitute fuels using this machine. The W 80 Windsifter is ideally equipped for use with numerous different materials.

- The infeed hopper is equipped with the proven positive-fitting drive system of the Terra Select trommel screens. In addition, a metering roller ensures an even infeed of material into the machine.
- The W 80 Windsifter impresses with a high, continuously adjustable cleaning level at throughput rates of up to 120 m³/h.
- The Terra Select W 80 offers easy accessibility to all components.

Special features: energy efficient direct drive, hopper with metering roller, optional discharge conveyor for light fraction

Working position

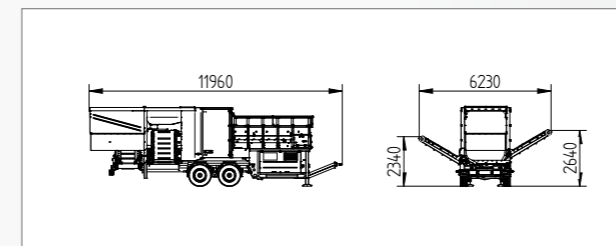

Transport position

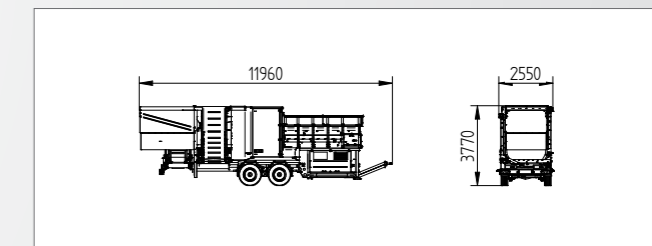

Plain text display



Discharge conveyor for heavy fraction



Windsifter - Terra Select W 80



Eggersmann

Eggersmann GmbH

HO Halle
Ravenna-Park 2
33790 Halle (Westf.)
Germany

Technology Center Screening
Rudolf-Diesel-Straße 5
48336 Sassenberg
Germany
Fon +49 2583 9197-0
Fax +49 2583 9197-10

info@f-e.de
www.f-e.de



ClimatePartner^o
climate neutral

Print | ID 11242-1607-1008

Find us on

